

Lenox Sound[®]

AM/FM STEREO PROGRAMMABLE COMPACT DISC PLAYER

MODEL CD-107
OPERATING INSTRUCTIONS

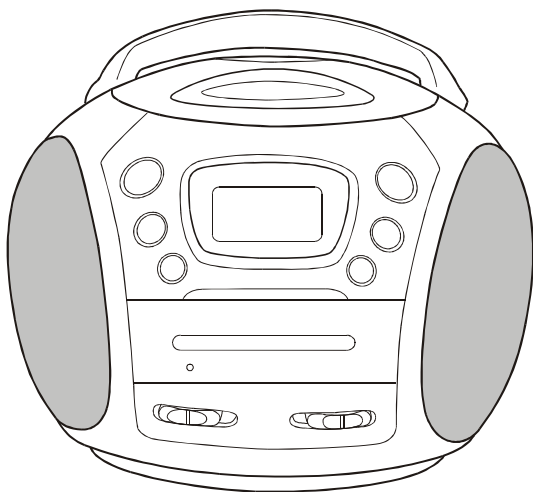

- **PLAYS MUSIC COMPACT DISCS**
- **FULLY PROGRAMMABLE CD PLAYER WITH REPEAT PLAY**
- **RECEIVES AM/FM STEREO BROADCASTS**
- **FM STEREO AND POWER LED INDICATORS**
- **2 WAY POWER - AC/DC**
- **REQUIRES 6 SIZE "C" BATTERIES (not included)**

PLEASE READ CAREFULLY BEFORE USE

IB-CD107(AD)-FD-E-V1

SAFETY INSTRUCTIONS



The lightning flash and arrow head within the triangle is a warning sign alerting you of "dangerous voltage" inside the product.

CAUTION

**RISK OF ELECTRIC SHOCK
DO NOT OPEN**

CAUTION: TO REDUCE THE RISK OF ELECTRIC SHOCK, DO NOT REMOVE COVER (OR BACK). NO USER SERVICEABLE PARTS INSIDE. REFER SERVICING TO QUALIFIED SERVICE PERSONNEL.



The exclamation point within the triangle is a warning sign alerting you of important instructions accompanying the product.

SEE BOTTOM OF THE SET

WARNING: TO REDUCE THE RISK OF FIRE OR ELECTRIC SHOCK, DO NOT EXPOSE THIS APPLIANCE TO RAIN OR MOISTURE.

THESE IMPORTANT SAFETY INSTRUCTIONS ARE INCLUDED, AS APPLICABLE TO THE APPLIANCE, CONVEYING TO THE USER THE INFORMATION ITEMIZED BELOW:

1. **Read Instructions** - All the safety and operating instructions should be read before the appliance is operated.
2. **Retain Instructions** - The safety and operating instructions should be retained for future reference.
3. **Heed Warnings** - All warnings on the appliance and in the operating instructions should be adhered to.
4. **Follow Instructions** - All operating and use instructions should be followed.
5. **Water and Moisture** - The appliance should not be used near water - for example near a bathtub, washbowl, kitchen sink, laundry tub, in a wet basement, or near a swimming pool, and the like.
6. **Wall or Ceiling Mounting** - The appliance should not be mounted to a wall or ceiling.
7. **Ventilation** - The appliance should be situated so that its location or position does not interfere with its proper ventilation. For example, the appliance should not be situated on a bed, sofa, rug, or similar surface that may block the ventilation openings; or, placed in a built-in installation, such as a bookcase or cabinet that impede the flow of air through the ventilation openings.
8. **Heat** - The appliance should be situated away from heat sources such as radiators, heat registers, stoves, or other appliances (including amplifiers) that produce heat.
9. **Power Sources** - The appliance should be connected to a power supply only of the type described in the operating instructions or as marked on the appliance.
10. **Grounding or Polarization** - Precautions should be taken so that the grounding or polarization means of an appliance is not defeated.
11. **Power Cord Protection** - Power supply cords should be routed so that they are not likely to be walked on or pinched by items placed upon or against them, paying particular attention to cords at plugs, convenient receptacles, and the point where they exit from the appliance.
12. **Cleaning** - The appliance should be cleaned only as recommended by the manufacturer.
13. **Nonuse periods** - The power cord of the appliance should be unplugged from the outlet when left unused for a long period of time.

SAFETY INSTRUCTIONS

14. **Object and Liquid Entry** - Care should be taken so that objects do not fall and liquids are not spilled into the enclosure through openings.
15. **Damage Requiring Service** - The appliance should be serviced by qualified service personnel when:
 - A. The power supply cord or the plug has been damaged; or
 - B. Objects have fallen, or liquid has been spilled into the appliance; or
 - C. The appliance has been exposed to rain; or
 - D. The appliance does not appear to operate normally or exhibits a marked change in performance; or
 - E. The appliance has been dropped, or the enclosure damaged.
16. **Servicing** - The user should not attempt to service the appliance beyond that described in the operating instructions. All other servicing should be referred to qualified service personnel.
17. **Power lines** - An outdoor antenna should be located away from power lines.
18. **Outdoor Antenna Grounding** - If an outside antenna is connected to the receiver, be sure the antenna system is grounded so as to provide some protection against voltage surges and built up static charges. Section 810 of the National Electrical Code, ANSI/NFPA 70 provides information with respect to proper grounding of the mast and supporting structure, grounding of the lead-in wire to an antenna discharge unit, size of grounding conductors, location of antenna-discharge unit, connection to grounding electrodes, and requirements for the grounding electrode. See Figure.

EXAMPLE OF ANTENNA GROUNDING AS PER
NEC - NATIONAL ELECTRICAL CODE

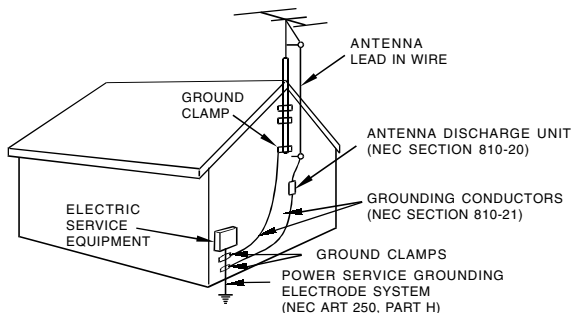

Do not apply oil or petroleum products or solvents to any part of this set.

CAUTION

Use of controls or adjustments or performance of procedures other than those specified herein may result in hazardous radiation exposure.
This compact disc player is classified as CLASS 1 LASER PRODUCT as stated on the bottom of the set.

BATTERY SAFETY INSTRUCTIONS

CAUTION: TO REDUCE THE RISK OF FIRE OR PERSONAL INJURY OR DAMAGE TO YOUR SET, READ AND FOLLOW THESE INSTRUCTIONS.

1. Use only the type and size of batteries mentioned in the operating instructions booklet (batteries are not included with this set, please buy the proper batteries).
2. Do not dispose the batteries into a fire. The cells may explode. Check with local codes for possible special disposal instructions.
3. Do not open or mutilate the batteries. Released electrolyte is corrosive and may cause damage to the eyes or skin. It may be toxic if swallowed.
4. Be careful when handling batteries in order not to short the battery with conducting materials such as rings, bracelets and keys. The battery or conductor may over heat and cause burns.
5. Do not attempt to recharge non-rechargeable batteries. The batteries may leak corrosive electrolyte or explode.
6. Do not attempt to rejuvenate the batteries identified for use with this product by heating them. Sudden release of the battery electrolyte may cause burns or irritation to eyes or skin.
7. All batteries should be replaced at the same time. Mixing fresh and discharged batteries could increase internal cell pressure and rupture the batteries.
8. When inserting batteries into this product, the proper polarity (\oplus and \ominus) or direction must be observed. Reverse insertion of some or all of the batteries may result in battery electrolyte leakage or explosion.
9. Remove the batteries from this product if the product will not be used for a long period of time (several months or more) since during the period the batteries could leak, damaging the product.
10. Discard weak or dead batteries as soon as possible since they are more likely to leak in the product. Batteries should be replaced (depending on the product) when the display gets dim or if the Low Battery Indicator shows or if the sound gets distorted.
11. Do not store this product in high temperature areas. Batteries that are stored in a freezer or refrigerator for the purpose of extending shelf life should be protected from condensation during storage and defrosting. Batteries should be stabilized at room temperature prior to use after cold storage.
12. If this product does not operate normally, see TROUBLE SHOOTING in this instruction manual. If you can't resolve the problem, or if the product is damaged, refer to the LENOXX WARRANTY INFORMATION. Opening or removing covers may expose you to dangerous voltages or other risks. Incorrect reassembly can cause electric shock when the appliance is subsequently used.
13. If liquid leaks from the batteries, carefully wipe this liquid. Do not allow it to touch your skin, and discard the leaking batteries.
14. Do not mix batteries (OLD and NEW or CARBON and ALKALINE, etc.).
15. The use of rechargeable batteries is not recommended for this set because their voltage and life is lower than standard batteries.
16. Installation of batteries should be done by an adult only.

SAVE THESE INSTRUCTIONS

CHOOSING THE POWER SOURCES

You can use the AC power or batteries as a power source.

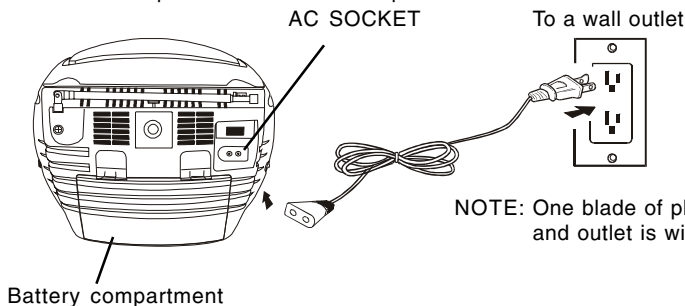

TIP

- If the plug of the AC power cord does not match your outlet, do not force it. Reverse it and try again. The plugs are polarized and only fits one way into the wall outlet and back of the set.

- Replace the batteries when the POWER lamp dims or when the player stops operating. Replace all the batteries with new ones. Before you replace the batteries, be sure to take out the CD from the player and remember to check the Battery Safety Instructions on Page 3.

1. Connecting the AC power cord

Insert one end of the supplied AC power cord (located in the battery compartment) into the socket located at the rear of the player, and the other end to the wall outlet.

2. Using the player on batteries

Insert 6 size "C" batteries (not supplied) into the battery compartment.

To use the player on batteries, disconnect and remove the AC power cord from the player.

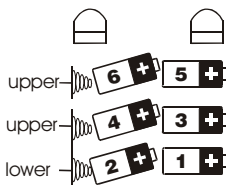

FIG. 1

Insert new batteries according to sequence as shown on FIG. 1.

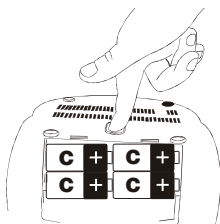
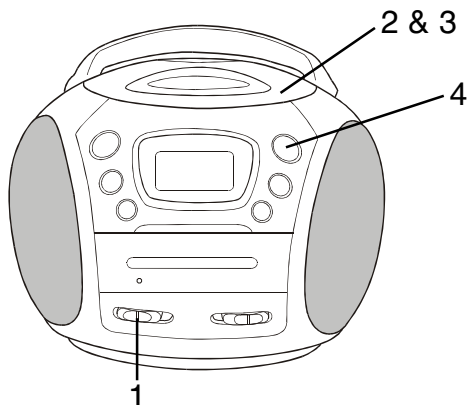

FIG. 2

To remove the batteries, (open the door) stick your finger into the hole on the bottom of the set and push the batteries out as shown on FIG. 2.

PLAYING A CD



Connect the supplied AC power cord or batteries (see page 4).

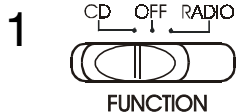

Slide the **FUNCTION** switch to **CD** position, the **POWER** lamp will turn on.

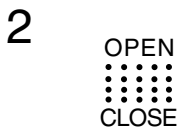
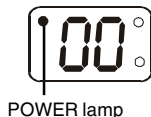

Press the right corner of the **CD DOOR** marked **OPEN/CLOSE** to open the door and place the **CD** in the **CD compartment**. The label side of the **CD** should face upward.

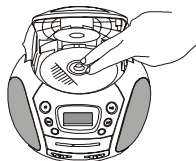

Close the **CD DOOR** by pushing it down. The display will show the total tracks on that **CD**.



Press the **CD PLAY** button. The **PLAY/PROG.** lamp will be steady on, the player will play all the tracks in order once.

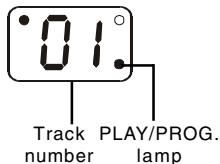

USE THESE BUTTONS FOR ADDITIONAL OPERATIONS



TIP

When CD play is paused, the track number will flash and no music will play.

To resume play, press the PAUSE button again, the track number will stop flashing and music will play.

TIP

If you bump the set during CD play, the music will stop or skip for a few seconds. This is normal for this type of player.

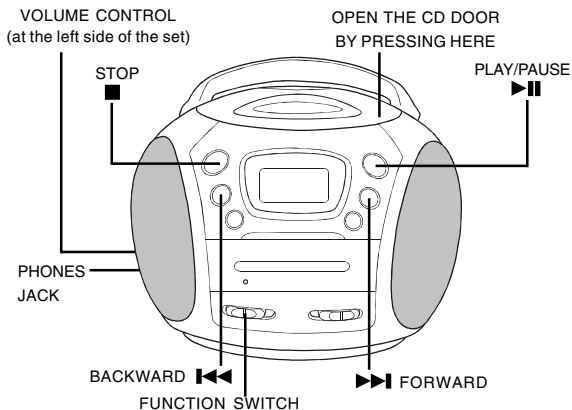



To	Press or Adjust
Adjust the volume	VOLUME control
Stop playback	STOP ■
Pause playback	PLAY/PAUSE ►► The track number will flash during pause. Press again to resume play after pause.
Go to the next track	►► FORWARDS
Go back to the previous track	◄◄ BACKWARDS
Locate a point in a song	BACKWARDS ◄◄ or FORWARDS ►► Press and hold down while playing until you find the point.
To enjoy the music without disturbing others	Insert your headphone (optional - not included) plug into the PHONES jack (at the left side of the set)
Remove the CD	Press the right corner of the CD DOOR marked OPEN/CLOSE (press STOP first)
Turn off the power	Slide the FUNCTION switch to OFF position

PLAYING CD TRACKS REPEATEDLY (REPEAT PLAY)

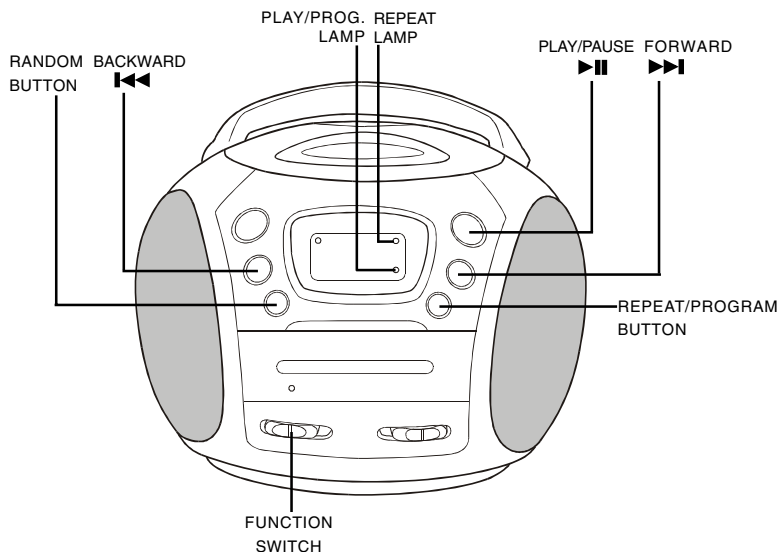
You can play CD tracks over and over in normal or program play modes (see page 8).



1. Slide the FUNCTION switch to the CD position.
2. Select the track by pressing SKIP/SEARCH BACKWARD **⏮** or FORWARD **⏭**, and then press **⏪**.
3. Press the CD REPEAT/PROGRAM button.

To repeat	Press	Display shows
a single track (song)	Press the REPEAT/PROGRAM button once, the REPEAT lamp will be steady on.	 REPEAT PLAY/ PROG.
all the tracks (all songs)	Press the REPEAT/PROGRAM button twice, the REPEAT lamp will be flashing.	 REPEAT PLAY/ PROG.
programmed tracks	During programmed play, press the REPEAT button twice, both the REPEAT and PLAY/PROG. lamps will be flashing.	 REPEAT PLAY/ PROG.

To cancel Repeat Play

Press the REPEAT/PROGRAM button until the REPEAT lamp goes off.

SELECTING YOUR OWN MUSIC PLAYING ORDER (Programmed Play)

You can make a program of up to 16 tracks in the order you want them to be played.

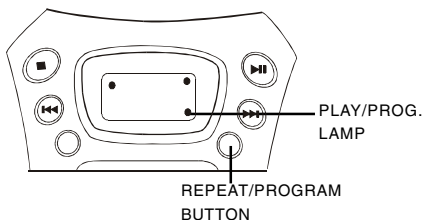

1. Slide the FUNCTION switch to CD position. Make sure the CD is stopped.
2. Press the REPEAT/PROGRAM button. The letters "P0" will show and the PLAY/PROG. lamp will flash.
3. Press ►► or ◀◀ to select the tracks you want to program in the order you want.
4. Press the REPEAT/PROGRAM button to confirm. The letters "P1" will show and the PLAY/PROG. lamp will flash.
5. Repeat steps 3 and 4. You can program up to 16 tracks (the display will show "Pa", "Pb" ... "Pf" for program#11-16).
6. Press ►► to start programmed play. The PLAY/PROG. lamp will be flash.



To change the current program

Just create a new program following the Programming procedure.

To cancel Programmed Play

Slide the FUNCTION switch to OFF position.

2. Random Play

To play the songs in random order

Press the RANDOM button, and the display will show some moving symbols like "◻ ... ◻ ... ◻" every 5 second.

Press ►► to skip to next random song.

To resume normal play

Press the RANDOM button again.

LISTENING TO THE RADIO

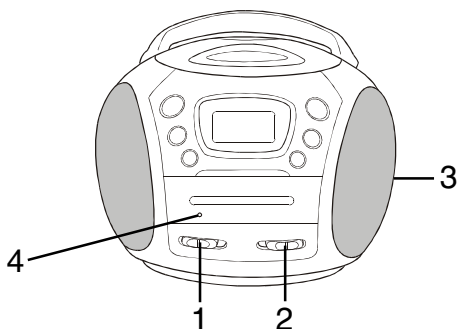

Connect the supplied AC power cord or batteries (see page 4).

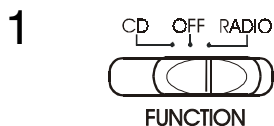

Slide the FUNCTION switch to RADIO position, the POWER lamp will turn on.

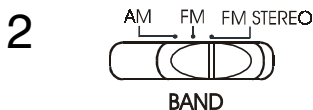

Slide the BAND switch to the proper band position (AM, FM, or FM STEREO) that you want.



Tune into the station you prefer using the TUNING control (at the right side of the set). Adjust for the clearest sound.



This indicator will light up when receiving FM Stereo broadcasts.

USE THESE BUTTONS FOR ADDITIONAL OPERATIONS

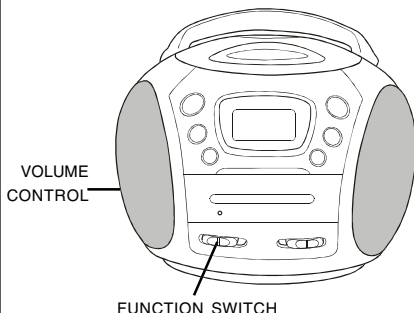

TIP

- If the FM broadcast is noisy, slide the BAND switch from FM Stereo to FM (MONO) position.
- Next time you want to listen to the radio, just slide the FUNCTION switch to RADIO. The player automatically starts playing the previously tuned station.

To	Slide or Adjust
Adjust the volume	VOLUME control (at the left side of the set)
Turn off the Radio	Slide the FUNCTION switch to OFF position

To improve broadcast reception

Change position of the antenna for FM or FM Stereo.
Move the set itself for AM.

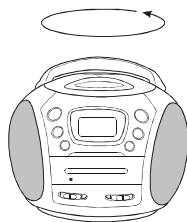
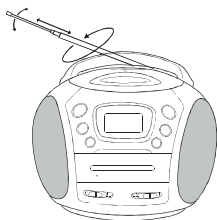

PRECAUTIONS

On Safety

- As the laser beam used in the CD player section may be harmful to the eyes, do not attempt to disassemble the cabinet. Refer servicing to qualified personnel only.
- Should any solid object or liquid fall into the player, unplug the player, and have it checked by qualified personnel before operating it any further.

On Placement

- Do not leave the player in a location near a heat source, or in a place subject to direct sunlight, excessive dust or mechanical shock.
- Do not place the player on an inclined or unstable place.
- Do not place anything within 1 inch of the back of the cabinet. The ventilation holes must not be covered for the player to operate properly and prolong the life of its components.
- If the player is left in a car parked in the sun, be sure to choose a location in the car where the player will not be subjected to the direct rays of the sun.
- Since a strong magnet is used for the speakers, keep personal credit cards using magnetic coding or springwound watches away from the player to prevent possible damage from the magnets.

On Power Sources

- For battery operation, use 6 size C batteries. We recommend alkaline batteries for longer life.
- When the batteries will not be used for a few weeks or more, remove them to avoid damage that can be caused by battery leakage or corrosion.

On Operation

- If the player is brought directly from a cold to a warm location, or is placed in a very damp room, moisture may condense on the lens inside the CD player section. Should this occur, the player will not operate properly. In this case, remove the CD and wait about an hour for the moisture to evaporate.
- This CD player is designed to be played on a stable no vibration position. If you bump the set during CD play, the music will stop or skip for a few seconds. This is normal for this type of player.
- If you have any questions or problems concerning your player, please contact our customer service department.

PRECAUTIONS (continued)

Notes on CDs

- Before playing, clean the CD with a cleaning cloth. Wipe the CD from the center out.

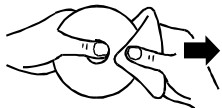

- Do not use solvents such as benzene, thinner, commercially available cleaners or anti-static spray intended for vinyl LPs.
- Do not expose the CD to direct sunlight or heat sources such as hot air ducts, nor leave it in a car parked in direct sunlight as there can be a considerable rise in temperature inside the car.
- Do not stick paper or stickers on the CD, nor scratch the CD.
- After playing, store the CD in its case. If there is a scratch, dirt or fingerprints on the CD, it may cause a tracking error or skipping.

MAINTENANCE

Cleaning the Lens

If the lens becomes dirty, it may cause a skipping of sound during CD operation. Clean with a commercially available lens cleaner and blower.

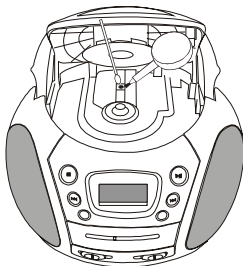

Cleaning the Cabinet

Clean the cabinet, panel and controls with a soft cloth slightly moistened with a mild detergent solution. Do not use any type of abrasive pad, scouring powder, or solvent, such as alcohol or benzene.

TROUBLE SHOOTING

	Problem	Remedy
General	The power is not on.	<ul style="list-style-type: none">• Connect the AC power cord to a wall outlet securely.• Make sure the batteries are inserted correctly and they are fresh.
	There is no sound.	<ul style="list-style-type: none">• Make sure the FUNCTION switch is at the right position as you want.• Adjust the volume.• Unplug the headphones when listening through speakers.
	"no" appears in the display even when a CD is in place.	<ul style="list-style-type: none">• Insert the CD with the label side up.
CD player	CD does not play.	<ul style="list-style-type: none">• Make sure that the CD compartment is closed.• Place the CD with the label side up.• Clean the CD.• Take out the CD and leave the CD DOOR open for about an hour to dry moisture condensation.• Make sure the FUNCTION switch is at CD position.
	The sound drops out.	<ul style="list-style-type: none">• Clean the CD, or replace it if the CD is badly damaged.• Place the player in a location free from vibration.• Check if your batteries are fresh.
Radio	The sound is weak or has poor quality.	<ul style="list-style-type: none">• Replace all the batteries with new ones if they are weak, or bring the set near a window, or rotate the set.

SPECIFICATION

General Description

Power source:	AC 120V, 60Hz 12Watts DC 9V (6 size "C" batteries) (Alkaline batteries are recommended)
Speakers:	2 - 3" 8 ohm
Output power:	1.5W/channel
Dimensions:	Width: 9 1/2" Depth: 9" Height: 6 1/2" Weight: 3.5LBs (without batteries)

CD Section

Plays disc type:	Any normal CD used in portable players	
Laser wavelength:	760 - 800 NM	
Tracking method:	3 - spot error detection	3.86 mm lens
Frequency response:	50Hz - 15kHz +1/-2dB	

NOTE: This CD player will only play **NORMAL** music CDs (or CD-R CDs).
This set will not play **CDRW** encoded discs.

Radio Section

Frequency range:	FM: 88 - 108 MHz
	AM: 530 - 1700 kHz

LENOXX reserves the right to make design and specification changes for product improvement.

PROTECT YOUR FINE FURNITURE!

WE RECOMMEND A CLOTH OR OTHER PROTECTIVE MATERIAL BE PLACED UNDER THE SET WHEN PLACING IT ON SURFACE WITH A NATURAL OR LACQUER FINISH.

For customer service

Dial 1-800-315-5885 (MONDAY - THURSDAY 9:00 AM - 5:00 PM, FRIDAY 9:00 AM - 1:00 PM EST)

or Visit Our Website: <http://www.lenoxx.com>

© 2001 LENOXX ELECTRONICS CORP.
2 GERMAK DRIVE
CARTERET, N.J. 07008
MADE & PRINTED IN CHINA